

高端手术室系统设备专业品牌

Dongguan Great Innovating Co.,Ltd.

CE/ISO/FDA/CFDA

Address: No.2,. Muchang street, Shilong town

Dongguan city, Guangdong, 523000, China

Tel/WhatsApp/Wechat:0086-18575285875

Skype: greatingluis@hotmail.com

E: Luis@greatingmedical.com

www.greatingmedical.com

PLM-700 / 500-TV 3-Arm



采用德国欧司朗灯珠, 耐用50,000小时
色温可五档调节

German brand **OSRAM** LED bulbs with 50,000 hours life
Color temperature adjustable



LED冷光源,
头部温升小于1°C

LED cold light,
head temperature rise less
than 1°C



可拆卸式灭菌柄,
方便消毒

Removable sterilizer handle

PLM-700/500-TV采用LED冷光源设计, 并配有高清摄像系统, 满足手术室各种手术照明要求, 并可进行图像传输, 便于临床教学和存储。

PLM-700/500-TV adopts LED cold light source and has HD camera system, which can be used for all kinds of surgeries.



采用最先进的PWM调光技术,
无频闪, 减缓眼睛疲劳

PWM dimming technology,
no flickering



超薄型灯头设计,
美观大方

Beautiful ultra-thin lamp
head design



悬浮镜技术, 深度照明

Deep illumination

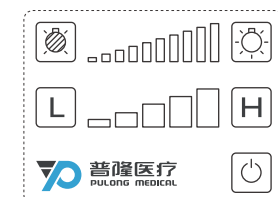

LCD触摸显示屏
LCD control panel

10档亮度调节
10 steps adjustable illumination

5档色温调节功能
5 steps adjustable color temperature



索尼高清摄像头
SONY: HD camera

戴尔显示器同步显示
DELL Monitor



大容量硬盘录像机

Large capacity video recorder



可选配备用电源

Optional UPS



欧司朗灯珠

OSRAM LED



PLM-700/500-R9采用LED冷光源设计，并配用R9功能，红光和绿光模式可调，满足手术室各种手术照明要求。

PLM-700/500-R9 adopts LED cold light source and has R9 mode. It has red light and green light mode, which can be used for all kinds of surgeries.

型号 Type	PLM-700	PLM-500
灯头直径 Head Diameter (mm)	700	500
LED灯珠数量 LEDs	81	51
照度 (10档可调) Illumination	40~160klx	
显色指数 CRI	Ra>95	
色温 (5档可调) Color temperature	3500-5000K	
照明深度 Illumination Depth	1200	
光斑直径 Spot diameter	120-300mm	
LED使用寿命 LED Life	>50,000 Hours	
R9模式 R9 Mode	Available	
红绿光模式 Red & Green Mode	Available	
LED灯珠品牌 LED Brand	OSRAM	
备用电源 UPS	Optional	

PLM-700/500-R9



PMMA光学透镜具备特有的聚光技术，可提高光效
PMMA optical lens with unique lighting collecting technology, improve the light efficiency

每一层光斑以同心圆的方式叠加而成
Multi-patch superposition to generate a uniform surgical light beam



采用最先进的PWM调光技术，
无频闪，减缓眼睛疲劳

PWM dimming technology,
no flickering



5英寸LCD触摸显示屏
5" LCD control panel



超薄灯头设计，美观大方
Beautiful ultra-thin lamp head design

PLM-700 / 500-NEW

PLM-700/500-NEW无影灯采用LED冷光源设计,带有腔镜照明功能,满足手术室各种手术照明要求。

PLM-700/500-NEW operating light use LED cold light source, which can be used for all kinds of surgeries. This operating light has the endoscopic surgery mode function.



欧司朗LED灯珠
OSRAM LED



可选配备用电源
Optional UPS



腔镜模式
Endoscopic surgery mode function

型号_Type	PLM-700 Main lamp	PLM-500 Main lamp
灯头直径_Head Diameter	700mm	500mm
LED灯珠数量_LEDS	80	48
照度(10档可调)_Illumination	40~160klx	
显色指数_CRI	Ra>98	
色温(5档可调)_Color Temperature	3500-5000K	
照明深度_Illumination Depth	1200mm	
光斑直径_Spot Diameter	120-300mm	
LED使用寿命_LED Life	>50,000 Hours	
腔镜模式_ENDO Mode	Available	
LED灯珠品牌_LED Brand	OSRAM	
备用电源_UPS	Optional	



进口欧达尔平衡臂
Germany brand Ondal spring arms



可拆卸式灭菌柄,方便消毒
Removable sterilizer handle



悬浮镜技术,深度照明
Deep illumination

采用最先进的PWM调光技术,无频闪,减缓眼睛疲劳
PWM dimming technology, no flickering



超薄型灯头设计,美观大方
Beautiful ultra-thin lamp head design



采用5寸LCD触摸显示屏
5"LCD control panel

10档亮度调节
10 steps adjustable illumination

5档色温调节功能
5 steps adjustable color temperature

PLM-500

PLM-700

PLM-500L



LCD触摸显示屏
LCD control panel

10档亮度调节
10 steps adjustable illumination

5档色温调节功能
5 steps adjustable color temperature

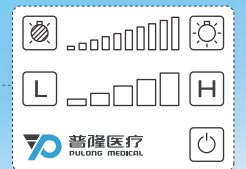

PLM-500L可移动式LED手术无影灯配有可移动式脚轮和备用电池, 非常方便宠物医院和诊所灵活使用。

PLM-500L Mobile LED surgical light has wheels and battery, which is very convenient for pet hospitals and clinics.



欧司朗LED灯珠
OSRAM LED



超薄型灯头设计, 美观大方
Beautiful ultra-thin lamp head design



进口欧达尔平衡臂. Germany brand Ondal spring arms



配有大容量备用电池
Big capacity battery



可移动式脚轮
Castors with brakes

型号. Type	PLM-700 Main lamp	PLM-500 Main lamp
灯头直径. Head Diameter	700mm	500mm
LED灯珠数量. LEDS	80	48
照度 (10档可调). Illumination		40~160klx
显色指数. CRI		Ra>95
色温 (5档可调). Color Temperature		3500-5000K
照明深度. Illumination Depth		1200mm
光斑直径. Spot Diameter		120-300mm
LED使用寿命. LED Life		>50,000 Hours
LED灯珠品牌. LED Brand		OSRAM
备用电源. UPS		Optional

PLDY-100T 电动液压手术台

Electric Hydraulic Operating Table

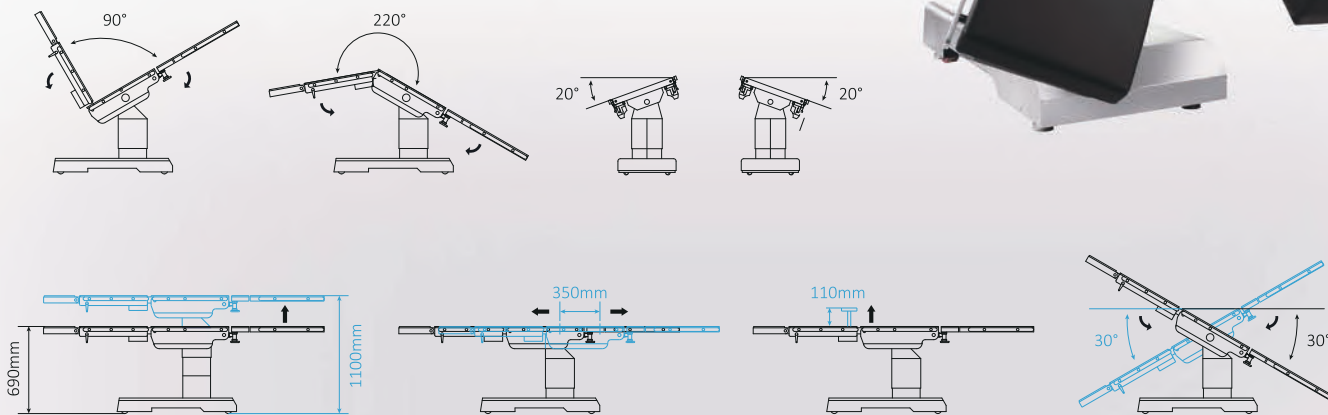

■ 四点式电动液压刹车
Four point electric hydraulic brake

■ 带一键复位功能
One button zero position

■ 腿板可电动液压升降
Leg section is also electric hydraulic controlled

■ 平移距离350mm,适合C型臂使用
Sliding distance 350mm, which is C-arm compatible

■ 配侧面控制系统,使操作更灵活方便
Equipped with side controller

■ 带一键正V反V功能
With flex/ reflex function

■ 内置大容量蓄电池,断电后可继续使用50-80次手术
Big capacity battery for 50-80 times surgery



主要技术参数. Main Specification

长/宽. Length / Width	2170mm / 550mm	背板上折/下折. Back Section Up/ Down	≥90° / ≥40°
高度. Height	690mm-1100mm	平移距离. Sliding Distance	≥350mm
后倾/前倾. Trendelenburg / Revers Trendelenburg	≥30° / ≥30°	腰桥升降. Kidney Bridge Lift	110mm
左右倾. Lateral Tilt	≥20° / ≥20°	正V/反V. Flex / Reflex	≥90° / 220°
头板上折/下折. Head Section Up / Down	≥40° / ≥90°	承重. Load Capacity	250kg
腿板上折/下折/外展. Leg Section Up / Down / Outside	≥15°/≥90° / ≥90°		

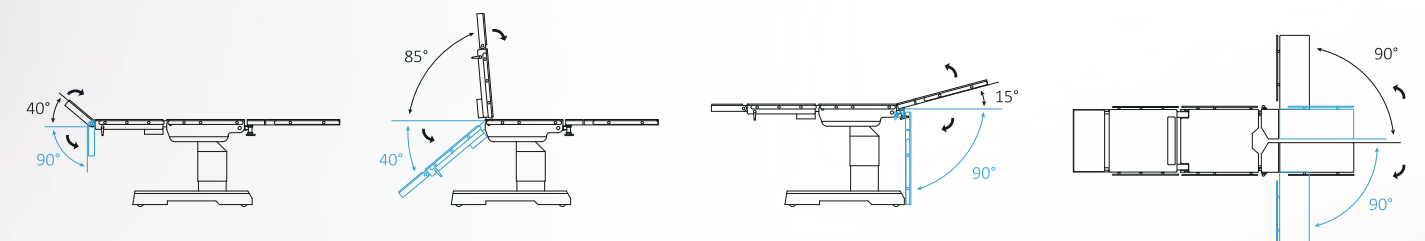

PLDOT-005 电动手术台

Electric Operating Table

该手术台为电动手术台, 所有动作都由进口电机控制。

PLDOT-005 is electric operating table, which all functions are controlled by imported motor.



- 平移距离350mm, 可配合C形臂使用
Sliding distance is 350mm, which can used with C-arm
- 8cm记忆海绵床垫
8cm memory sponge mattress
- 内置大容量蓄电池,
断电后可继续使用50-80次手术
Big capacity battery for 50-80 times surgery



主要技术参数. Main Specification

长/宽. Length / Width	2100mm / 550mm	腿板上折/下折/外展. Leg Section Up / Down / Outside	≥15°/≥90° / ≥90°
高度. Height	710mm-1010mm	背板上折/下折. Back Section Up/ Down	≥80° / ≥20°
后倾/前倾. Trendelenburg / Revers Trendelenburg	≥25° / ≥25°	平移距离. Sliding Distance	≥350mm
左右倾. Lateral Tilt	≥15° / ≥15°	腰桥升降. Kidney Bridge Lift	110mm
头板上折/下折. Head Section Up / Down	≥40° / ≥90°	承重. Load Capacity	250kg

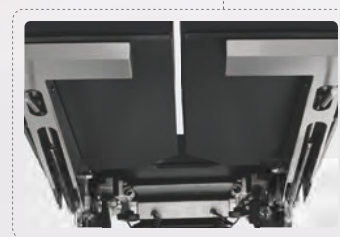

- 采用德国原装进口12cm脚轮,
经久耐用, 美观大方
Germany 12cm wheels, which is durable,
beautiful

- 配侧控系统
Side controller system

- 腿板由气压弹簧控制
Gas pressure controlled leg plate

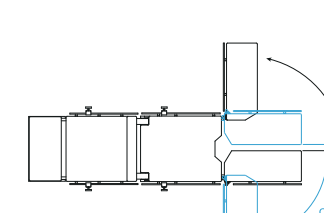
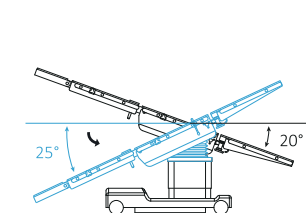
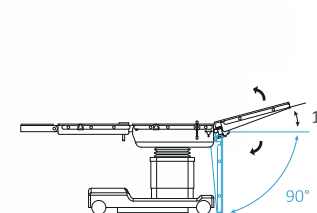
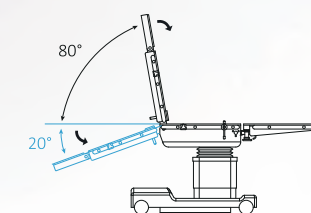
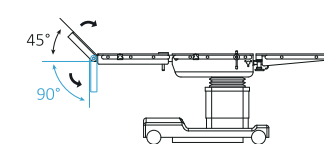
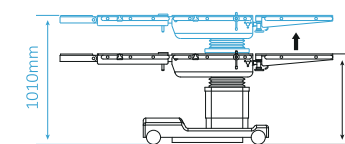
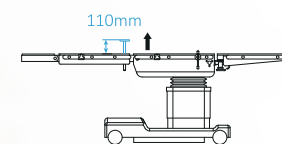
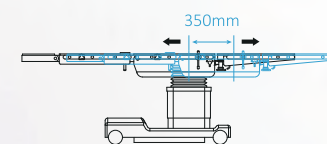
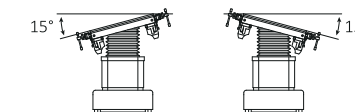

PLDOT-003 电动手术台

Electric Operating Table

该手术台为电动手术台, 所有动作都由进口电机控制。

PLDOT-003 is electric operating table, which all functions are controlled by imported motor.

■ 平移距离350mm, 可配合C形臂使用

Sliding distance is 350mm, which is C-arm compatible

■ 8cm记忆海绵床垫

8cm memory sponge mattress

■ 内置大容量蓄电池, 断电后可继续使用50-80次手术

Big capacity battery for 50-80 times surgery



主要技术参数. Main Specification

长/宽. Length / Width	2100mm / 550mm	腿板上折/下折/外展. Leg Section Up / Down / Outside	≥15°/≥90° / ≥90°
高度. Height	700mm-1000mm	背板上折/下折. Back Section Up/ Down	≥75° / ≥20°
后倾/前倾. Trendelenburg / Revers Trendelenburg	≥25° / ≥25°	平移距离. Sliding Distance	≥350mm
左右倾. Lateral Tilt	≥15° / ≥15°	腰桥升降. Kidney Bridge Lift	110mm
头板上折/下折. Head Section Up / Down	≥40° / ≥90°	承重. Load Capacity	250kg

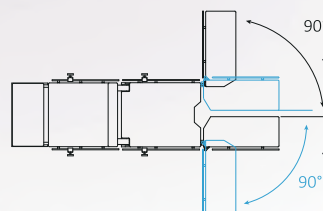
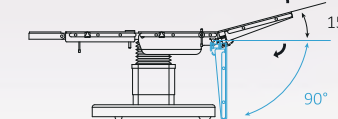
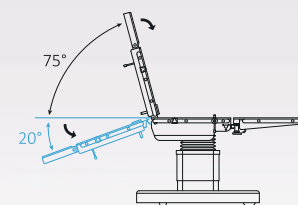
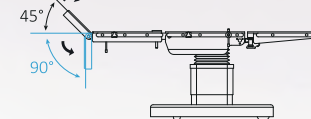
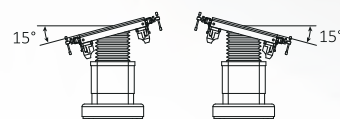
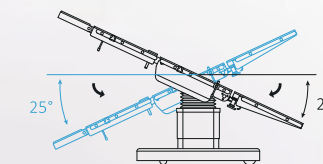
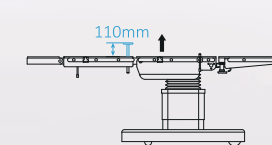
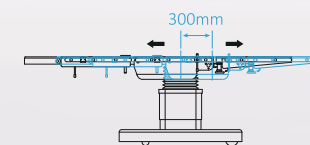
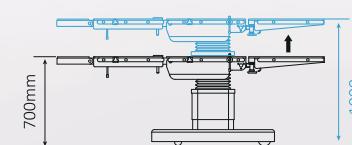
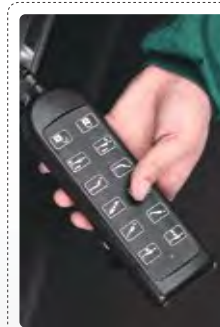

PLDOT-90A\90B 电动手术台

Electric Operating Table

该手术台为电动手术台,所有动作都由进口电机控制。

PLDOT-90A\90B is electric operating table, which all functions are controlled by imported motor.

■ 记忆海绵床垫

Memory sponge mattress

■ 内置大容量蓄电池,断电后可继续使用50-80次手术

Big capacity battery for 50-80 times surgery



PLDOT-90A

■ 平移距离350mm,
可配合C形臂使用

Sliding distance is 350mm,
which is C-arm compatible



PLDOT-90B

■ 台面最低550mm,
可配头架供眼科和脑外科使用

The table lowest height is 550mm.
It can be connected with skull clamp,
which can be used for Ophthalmology
and aural surgery.

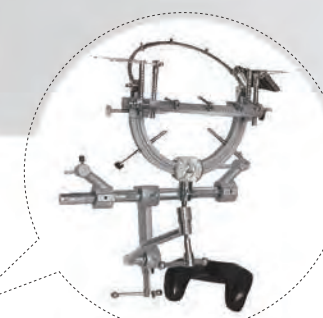

■ 可加装头架

Skull clamp compatible



主要技术参数. Main Specification

型号. Model	PLDOT-90A	PLDOT-90B
长/宽. Length / Width	2000mm / 500mm	2020mm / 500mm
高度. Height	750mm-1000mm	550mm-800mm
后倾/前倾. Trendelenburg / Revers Trendelenburg	≥25° / ≥25°	≥25° / ≥20°
左右倾. Lateral Tilt	≥20° / ≥20°	≥20° / ≥20°
头板上折/下折. Head Section Up / Down	≥45° / ≥90°	≥30° / ≥90°
腿板上折/下折/外展. Leg Section Up / Down / Outside	≥15°≥90° / ≥90°	≥15°≥90° / ≥90°
背板上折/下折. Back Section Up/ Down	≥70° / ≥35°	≥45° / ≥20°
平移距离. Sliding Distance	≥350mm	—
腰桥升降. Kidney Bridge Lift	100mm	80mm
承重. Load Capacity	250kg	250kg



3001S 综合手术台 Hydraulic Operating Table



该手术台为液压机械手术台，台面升降由进口液压系统控制。

PLYOT-3001S is hydraulic mechanic operating table. The table up-down function is hydraulic controlled.

主要技术参数. Main Specification

长/宽. Length / Width	2100mm / 500mm	腿板上折/下折/外展. Leg Section Up / Down / Outside	≥15°/≥90° / ≥90°
高度. Height	750mm-1000mm	背板上折/下折. Back Section Up/ Down	≥55° / ≥10°
后倾/前倾. Trendelenburg / Revers Trendelenburg	≥20° / ≥15°	平移距离. Sliding Distance	≥350mm
左右倾. Lateral Tilt	≥20° / ≥20°	腰桥升降. Kidney Bridge Lift	115mm
头板上折/下折. Head Section Up / Down	≥45° / ≥90°	承重. Load Capacity	250kg



台面可手动平移350mm,可配合C型臂使用
Sliding distance is 350mm, which is C-arm compatible



可选配骨科架
Orthopedics traction frame is compatible

3008S 综合手术台 Hydraulic Operating Table

主要技术参数. Main Specification

长/宽. Length / Width	2100mm / 500mm
高度. Height	750mm-1000mm
后倾/前倾. Trendelenburg / Revers Trendelenburg	≥20° / ≥20°
左右倾. Lateral Tilt	≥15° / ≥15°
头板上折/下折. Head Section Up / Down	≥45° / ≥90°
腿板上折/下折/外展. Leg Section Up / Down / Outside	≥15°/≥90° / ≥90°
背板上折/下折. Back Section Up/ Down	≥70° / ≥10°
腰桥升降. Kidney Bridge Lift	80mm
承重. Load Capacity	250kg

台面前后倾、左右倾、背板上下折均由进口气压弹簧控制，便于医护人员操作
The table trendelenburg and revers trendelenburg, lateral tilt, back up-down are all controlled by imported gas spring, which makes the operations easily.

立柱和底座为304不锈钢，易于清洗和消毒
The column and base cover are all stainless steel 304#, which is convenient for clean and disinfection.



该手术台为液压气动手术台，台面升降由进口液压系统控制。

PLYOT-3008S is hydraulic and pneumatic operating table. The table top up-down is hydraulic controlled.

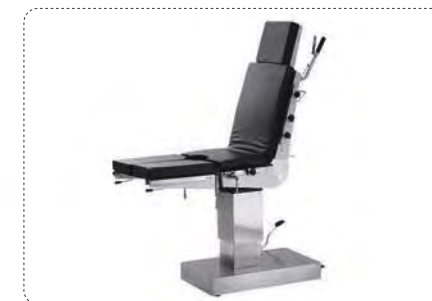

3008 综合手术台 Hydraulic Operating Table

该手术台为液压机械手术台,台面升降由进口液压系统控制。

PLYOT-3008 is hydraulic mechanical operating table. The table up-down is hydraulic controlled.



主要技术参数. Main Specification

长/宽. Length / Width	2080mm / 480mm	腿板上折/下折/外展. Leg Section Up / Down / Outside	$\geq 15^\circ \geq 90^\circ / \geq 90^\circ$
高度. Height	750mm-1000mm	背板上折/下折. Back Section Up/ Down	$\geq 90^\circ / \geq 10^\circ$
后倾/前倾. Trendelenburg / Revers Trendelenburg	$\geq 25^\circ / \geq 25^\circ$	腰桥升降. Kidney Bridge Lift	120mm
左右倾. Lateral Tilt	$\geq 18^\circ / \geq 18^\circ$	承重. Load Capacity	250kg
头板上折/下折. Head Section Up / Down	$\geq 45^\circ / \geq 90^\circ$		



整个手术台台面均为304不锈钢,经久耐用,易于清洗和消毒。

The table top are all stainless steel 304#, which is durable and convenient for clean and disinfection.

3001 综合手术台 Hydraulic Operating Table

该手术台为液压机械手术台,台面升降为进口液压系统控制

PLYOT-3001 is hydraulic mechanical operating table. The table up-down is hydraulic controlled.



立柱和底外罩均为304不锈钢,便于消毒和清洗

The column and base cover are all stainless steel 304#, which is convenient for clean and disinfection.

主要技术参数. Main Specification

长/宽. Length / Width	2000mm / 480mm	腿板上折/下折/外展. Leg Section Up / Down / Outside	$\geq 15^\circ \geq 90^\circ / \geq 90^\circ$
高度. Height	720mm-980mm	背板上折/下折. Back Section Up/ Down	$\geq 75^\circ / \geq 18^\circ$
后倾/前倾. Trendelenburg / Revers Trendelenburg	$\geq 30^\circ / \geq 20^\circ$	腰桥升降. Kidney Bridge Lift	115mm
左右倾. Lateral Tilt	$\geq 18^\circ / \geq 18^\circ$	承重. Load Capacity	250kg
头板上折/下折. Head Section Up / Down	$\geq 45^\circ / \geq 90^\circ$		



PLOT-01 普通手术台 Ordinary Operating Table



该手术台为普通手术台，立柱罩和底罩均为304不锈钢，便于消毒清洗。

PLOT-01 is general operating table. The column and base cover are all stainless steel 304#, which is convenient for clean and disinfection.

主要技术参数. Main Specification

长/宽. Length / Width	2000mm / 480mm	腿板上折/下折/外展. Leg Section Up / Down / Outside	≥15°/≥90° / ≥90°
高度. Height	750mm-850mm	背板上折/下折. Back Section Up/ Down	≥45° / ≥20°
头板上折/下折. Head Section Up / Down	≥45° / ≥90°	腰桥升降. Kidney Bridge Lift	100mm

PLGK-08 万能骨科手术台 Multi-purpose Traction Frame

万能型骨科手术台可配合任何手术台使用。

PLGK-08 multipurpose traction frame can be used with various operating tables.

主要技术参数. Main Specification

高度. Height	750-1000mm
牵引距离. Traction Distance	200mm
骨科架张开角度. Traction Frame Pipes Opened	60°



PLGYN-09A 电动产床 Electric Obstetric Bed

该产床台面升降、前后倾、背板折转均采用进口电机控制。

PLGYN-09A delivery bed up-down, trendelenburg and revers trendelenburg, back section are all controlled by imported motors.

配有隐藏式活动辅助台，方便医护人员操作

The leg board can be sliding under the seat board, which can be used for gynecology examination.

所有护罩、台面、污物盆均由304不锈钢制作，易于清洗和消毒。

All the cover, table top, basin are all made of stainless steel 304#, which is convenient for clean and disinfection.



主要技术参数. Main Specification

长/宽. Length / Width	1800mm / 600mm
高度. Height	700mm-950mm
后倾/前倾. Trendelenburg / Revers Trendelenburg	≥20° / ≥20°
背板上折. Back Section Up	≥75°
承重. Load Capacity	250kg

PLGYN-09B 电动产床

Electric Obstetric Bed



该产床上下升降、背板上下折、臀板上下折、刹车均采用进口电机控制

PLGYN-09B electric delivery bed up-down, back up-down, seat section up-down, brake lock and unlock are all controlled by imported motors.

净宽720mm,可适用于肥胖人群

The bed board width is 720mm, which can be used for obesity.

主要技术参数. Main Specification

长/宽. Length / Width	1980mm / 720mm	背板上折/下折. Back Section Up/ Down	≥75° / ≥20°
高度. Height	630mm-880mm	腿板外展. Leg section opened	≥90°
后倾/前倾. Trendelenburg/ Revers Trendelenburg	≥20° / ≥20°	承重. Load Capacity	250kg



坐板上折由电机控制

Electric controlled seat section up

床垫为无缝发泡垫,外形美观,易清洁

The mattress is seamless foaming pad, which is beautiful and easily for clean.

腿板可外摆90°,便于医护人员操作

The leg board can be opened 90°, which is convenient for operation.

配脚踏控制器

Foot controller



PLGYN-004 电动产床

Electric Obstetric Bed

该产床上下升降、背板上下折、臀板上下折(或前后倾)均采用进口电机控制

PLGYN-004 electric delivery bed up-down, back up-down, seat section up-down (or Trendelenburg and revers-trendelenburg) are all controlled by imported motors.

■ 床垫为无缝发泡垫, 外形美观, 易清洁
The mattress is seamless foaming pad, which is beautiful and easily for clean.

■ 腿板可外摆90°, 便于医护人员操作
The leg board can be opened 90°, which is convenient for operation.

■ 配脚踏控制器
The foot controller is standard configuration.

主要技术参数. Main Specification

长/宽. Length / Width	1900mm / 600mm	背板上折/下折. Back Section Up/ Down	≥70° / ≥10°
高度. Height	600mm-900mm	腿板外展. Leg section opened	≥90°
后倾/前倾. Trendelenburg / Revers Trendelenburg	≥20° / ≥20°	承重. Load Capacity	250kg

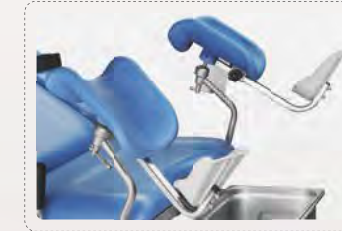

■ 所有护罩、台面、污物盆均由304不锈钢制作, 易于清洗和消毒。
All the cover, able top, basin are all made of stainless steel 304#, which is convenient for clean and disinfection.

■ 可选配检查灯, 用于妇科检查。
The examination light is optional, which can be used for gynecology examination.

PLVC-004 不锈钢住院氧舱理疗笼 Pet Hospital Infrared Therapy Cage



电源接口, 恒温控制
Power connector, thermostatic control system

主要技术参数. Main Specification

型号. Model	PLVC-004
长. Length	1220mm
宽. Width	700mm
高度. Height	1830mm
氧舱. Oxygen Chamber	4
恒温控制系统. Thermostatic control system	Standard

该理疗笼配有氧舱门和红外恒温理疗, 是一款高端的宠物住院笼。

This pet cage has inpatient oxygen chamber and Infrared thermostatic therapy. It is one luxury pet cage for veterinary hospitals.

PLVC-004-New 不锈钢住院氧舱理疗笼 Pet Hospital Infrared Therapy Cage



可触屏显示屏
Touch-screen display

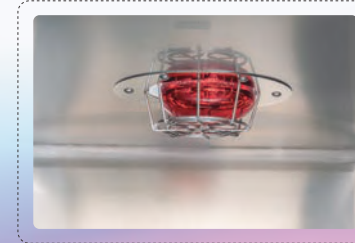

红外理疗灯
Infrared thermostatic therapy



配备氧舱, 温度和湿度显示
Oxygen chamber, Temperature and humidity display



可拆卸式托盘, 全圆角制作, 笼内无死角, 便于清理
Movable tray, easy to clean



主要技术参数. Main Specification

型号. Model	PLVC-004-NEW
长. Length	1220mm
宽. Width	700mm
高度. Height	1830mm
氧舱. Oxygen Chamber	4
恒温控制系统. Thermostatic control system	Standard

PLVC-A04 宠物住院笼 Pet Hospital Cage

该宠物全身均为优质304不锈钢制作。全圆角制作，笼内无死角，便于清理。

The pet cage is made by stainless steel 304. Full round corners, easy to clean.



主要技术参数. Main Specification

长. Length	1220mm
宽. Width	700mm
高度. Height	1570mm

PLVC-007 宠物住院笼 Pet Hospital Cage

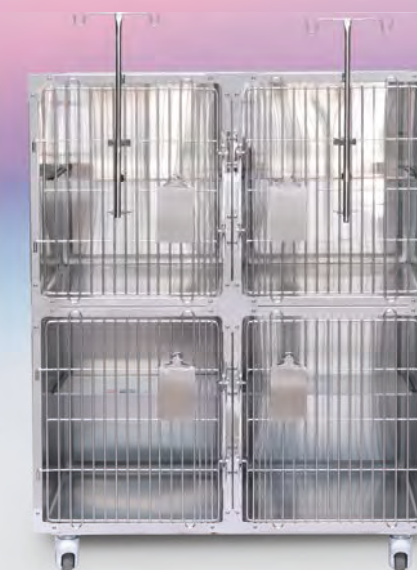
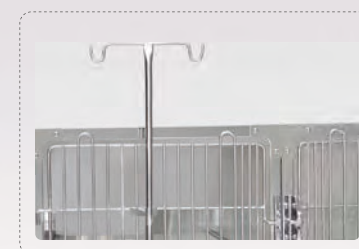
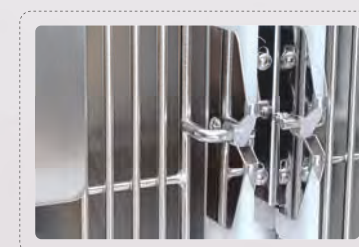

主要技术参数. Main Specification

型号. Model	PLVC-007
长. Length	1220mm
宽. Width	700mm
高度. Height	1570mm

PLVC-006 不锈钢豪华猫笼 Stainless Steel Luxury Cat Cage

该住院笼全部由304不锈钢制作。
This pet cage is made of 304 stainless steel.

- 每层独立的休闲区, 饮食区和卫生区
Each floor has separate eating, leisure and sanitation areas.
- 高强度亚克力抽板式设计
High-strength acrylic pumping board design.



主要技术参数. Main Specification

长. Length	1000mm
宽. Width	600mm
高度. Height	1700mm



PLVC-008 不锈钢豪华猫笼 Stainless Steel Luxury Cat Cage

主要技术参数. Main Specification

型号. Model	PLVC-008
长. Length	1000mm
宽. Width	600mm
高度. Height	1800mm

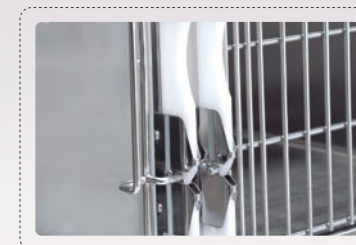
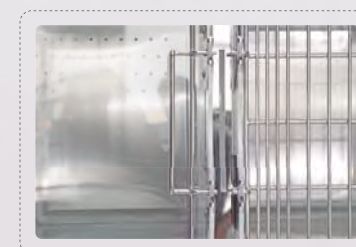

PLVC-009 不锈钢豪华猫笼 Stainless Steel Luxury Cat Cage

该宠物全身均为优质304不锈钢制作。全圆角制作, 笼内无死角, 便于清理。

The pet cage is made by stainless steel 304. Full round corners, easy to clean.

主要技术参数. Main Specification

长. Length	1500mm
宽. Width	600mm
高度. Height	1700mm



PLVC-005 不锈钢宠物住院笼

Stainless Steel Pet Cage



主要技术参数. Main Specification

型号. Model	PLVC-005
长. Length	1500mm
宽. Width	700mm
高度. Height	1570mm



PLVC-013 不锈钢宠物住院笼

Pet Hospital Cage

该住院笼全部由304不锈钢制作。

This pet cage is made of 304 stainless steel.

笼式结构合理, 超压, 坚固耐用。
Cage structure is reasonable, super pressure, strong and durable.

独特的推拉门锁设计, 自动上锁, 安全性好。
Unique sliding door lock design, automatic locking, good safety.



主要技术参数. Main Specification

长. Length	2400mm
宽. Width	700mm
高度. Height	2180mm

PLVC-001 宠物住院笼 Pet Hospital Cage

该宠物全身均为优质304不锈钢制作。全圆角制作，笼内无死角，便于清理。

The pet cage is made by stainless steel 304. Full round corners, easy to clean.

主要技术参数. Main Specification

长. Length	610mm
宽. Width	700mm
高度. Height	610-1410mm



PLVDC-04 不锈钢宠物展示笼 Stainless Steel Pet Display Cage

该宠物全身均为优质304不锈钢制作。全圆角制作，笼内无死角，便于清理。

The pet cage is made by stainless steel 304. Full round corners, easy to clean.



PLVC-002 宠物住院笼 Pet Hospital Cage

该住院笼全部由304不锈钢制作。

This pet cage is made of 304 stainless steel.

主要技术参数. Main Specification

长. Length	610mm
宽. Width	700mm
高度. Height	610-1410mm

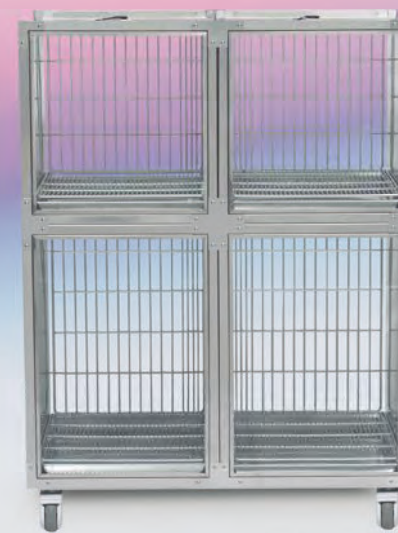

主要技术参数. Main Specification

型号. Model	PLVDC-04
长. Length	1220mm
宽. Width	700mm
高度. Height	1570mm

PLVOT-001 电动宠物手术台

Electric Pet Operating Table



■ 国产第一品牌, 捷昌电机
China most famous brand "jiechang" Motor



■ 不锈钢接污斗, 便于清理
stainless steel basin, easy to clean



■ 不锈钢手术托盘
Stainless steel surgical tray



■ 采用斜撑式升降支架, 升降平稳
Oblique lift bracket, lift smoothly

该手术台为电动手术台, 所有动作都由电机控制。床身材质均为304不锈钢。

PLVOT-001 is electric pet operating table, which all functions are controlled by motors. The table material is all stainless steel 304.



主要技术参数. Main Specification

型号. Model	PLVOT-001
长. Length	1300mm
宽. Width	600mm
高度. Height	450-1050mm
恒温控制系统. Thermostatic control system	Standard
承重. Load Capacity	250kg

PLVOT-002 电动宠物手术台

Electric Pet Operating Table

该手术台为电动手术台，所有动作都由电机控制。床身材质均为304不锈钢。

PLVOT-002 is electric pet operating table, which all functions are controlled by motors. The table material is all stainless steel 304.



PLVOT-002

- 台面由双夹板组成
Table top consists of 2 plates
- 台面夹板可成V型，便于手术
Both the table plates can tilt 45°, easy to clean

主要技术参数. Main Specification

型号. Model	PLVOT-002
长. Length	1400mm
宽. Width	650mm
高度. Height	760-1060mm
台面左右倾. Table Top Tilt	15°
夹板倾斜. Plate Tilt	45°
承重. Load Capacity	250kg



PLVOT-003 电动宠物手术台

Electric Pet Operating Table

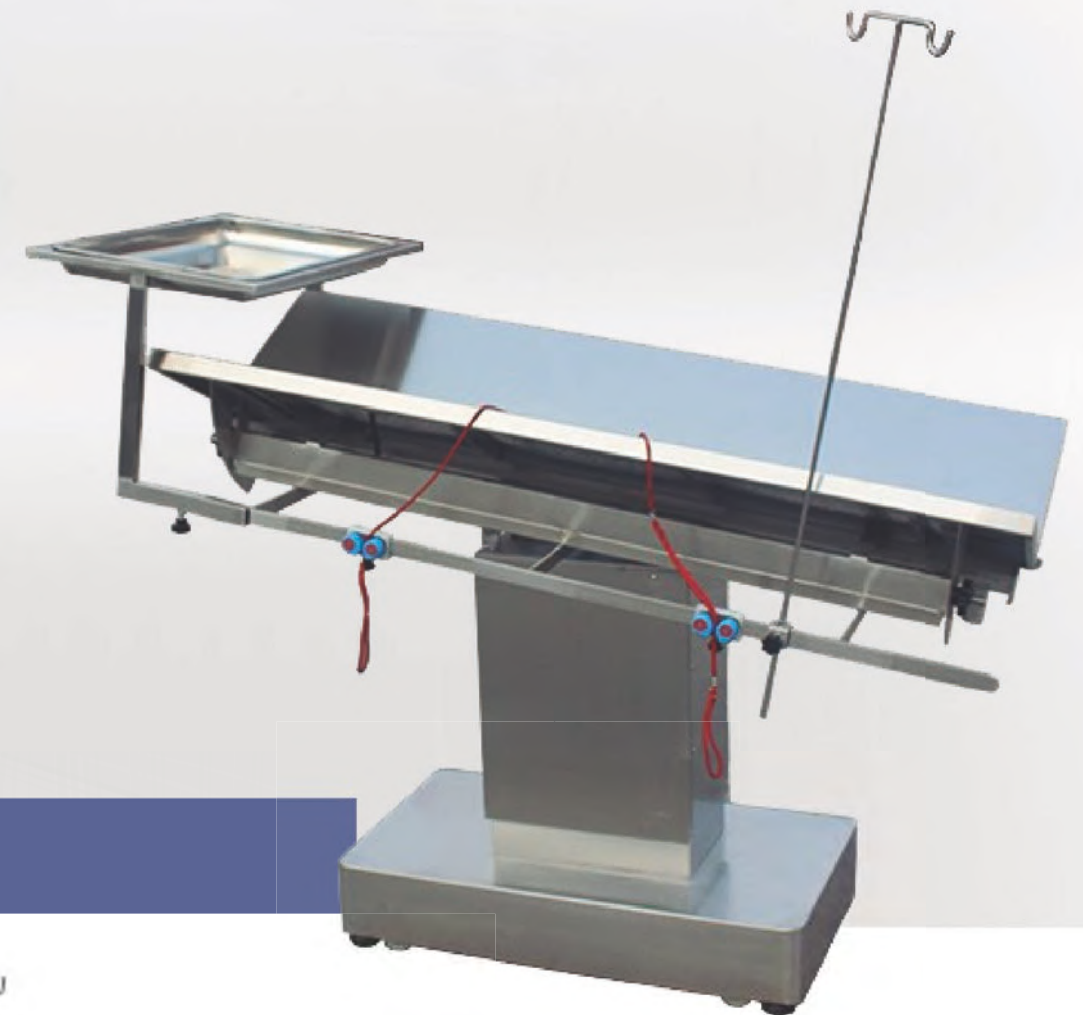

PLVOT-003

- 不锈钢接污斗，便于清理
Stainless steel funnel, easy to clean
- 不锈钢活动网片，便于清理
Stainless steel table top, easy to clean

主要技术参数. Main Specification

型号. Model	PLVOT-003
长. Length	1400mm
宽. Width	650mm
高度. Height	760-1060mm
恒温控制系统. Thermostatic control system	Standard
承重. Load Capacity	250kg



PLCZT-01 不锈钢处置台 Stainless Steel Disposal Table

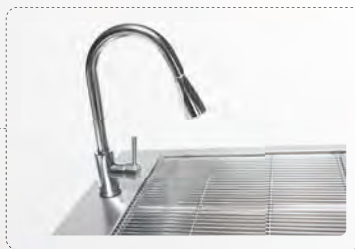

主要技术参数. Main Specification

型号. Model	PLCZT-01
长. Length	1400mm
宽. Width	600mm
高度. Height	850mm

PLST-03 不锈钢诊疗台 Stainless Steel Diagnosis Table

主要技术参数. Main Specification

型号. Model	PLST-03
长. Length	1400mm
宽. Width	650mm
高度. Height	850mm



PLZL-01 不锈钢诊疗台 Stainless Steel Diagnosis Table

主要技术参数. Main Specification

型号. Model	PLZL-01
长. Length	1100 mm
宽. Width	600mm
高度. Height	800mm



PLZL-03 不锈钢诊疗台 Stainless Steel Diagnosis Table

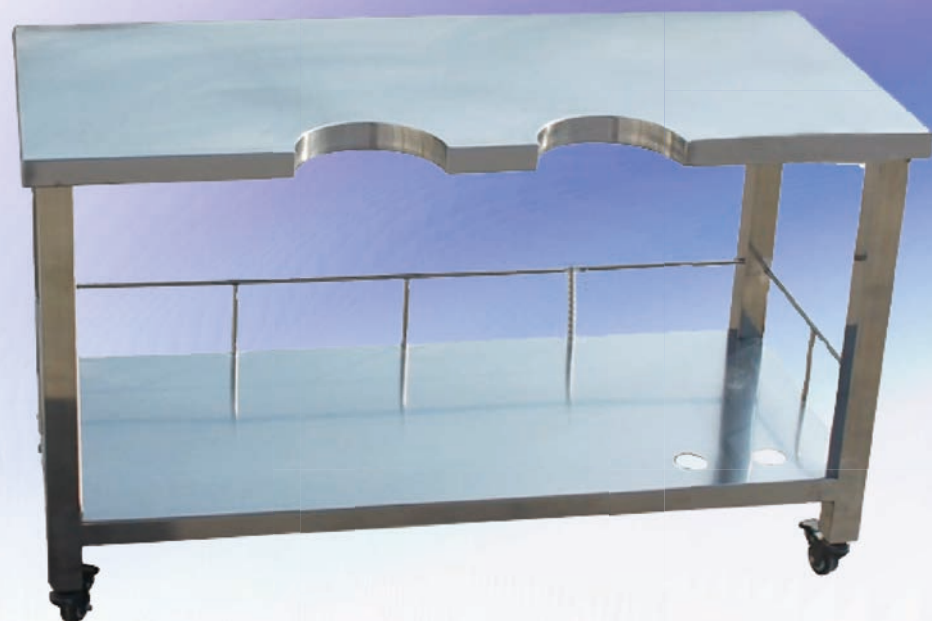

边缘处理圆润, 尺寸定制, 配备万能制动轮, 便于移动。
可用于清洁宠物牙齿、创伤治疗、接待等。

The edge treatment is rounded, the size is customized,
and the universal brake wheel is equipped to facilitate movement.

主要技术参数. Main Specification

型号. Model	PLZL-03
长. Length	1100mm
宽. Width	550mm
高度. Height	700mm

PLZL-08 不锈钢诊疗台 Stainless Steel Diagnosis Table



PLZL-07 不锈钢诊疗台 Stainless Steel Diagnosis Table



工作台高度采用电动踏板控制, 使用方便。
可用于清洁宠物牙齿、创伤治疗、接待等。

The height of the disposal table is controlled by electric pedal,
which is convenient to use.
Can be used for cleaning teeth with pets, trauma treatment, reception, etc.

主要技术参数. Main Specification

型号. Model	PLZL-07
长. Length	1200mm
宽. Width	600mm
高度. Height	750-1050mm



电动踏板控制台面高度, 使用方便, 高精度电子称重芯
可用于宠物的诊断和治疗、创伤治疗、接收、称重等

The height of the disposal table is controlled by an electric foot pedal,
which is convenient to use,
It can be used for pet diagnosis and treatment, trauma treatment,
reception, weighing, etc.

主要技术参数. Main Specification

型号. Model	PLZL-08
长. Length	900mm
宽. Width	500mm
高度. Height	750-1050mm

PLST-01 不锈钢豪华推车 Stainless Steel Luxury Trolley

主要技术参数. Main Specification

型号. Model	PLST-01
长. Length	700mm
宽. Width	450mm
高度. Height	800mm



PLST-04 不锈钢豪华推车 Stainless Steel Luxury Trolley

主要技术参数. Main Specification

型号. Model	PLST-04
长. Length	650mm
宽. Width	430mm
高度. Height	800mm

PLST-02 不锈钢豪华推车 Stainless Steel Luxury Trolley

主要技术参数. Main Specification

型号. Model	PLST-02
长. Length	545mm
宽. Width	455mm
高度. Height	1150mm



PLZL-02 不锈钢豪华推车 Stainless Steel Luxury Trolley

主要技术参数. Main Specification

型号. Model	PLZL-02
长. Length	900mm
宽. Width	500mm
高度. Height	850-1400mm

PLXYC-02 不锈钢洗浴水槽 Stainless Steel Bathing Water Tank

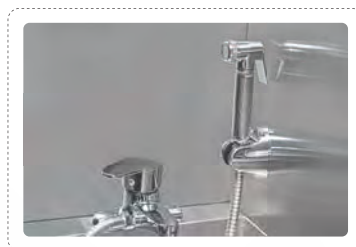

主要技术参数. Main Specification

型号. Model	PLXYC-02
长. Length	700mm
宽. Width	500mm
高度. Height	1100mm

PLXYC-01 不锈钢洗浴水槽 Stainless Steel Bathing Water Tank

主要技术参数. Main Specification

型号. Model	PLXYC-01
长. Length	620mm
宽. Width	500mm
高度. Height	800mm



PLXYC-03 不锈钢洗浴水槽 Stainless Steel Bathing Water Tank

全304不锈钢制作, 配有防滑踩脚网垫。
Main body is made of Stainless steel
#304, with Non-slip Footwear.

主要技术参数. Main Specification

型号. Model	PLXYC-03
长. Length	1300mm
宽. Width	740mm
高度. Height	900-1300mm



PLXYC-05 不锈钢洗浴水槽 Stainless Steel Bathing Water Tank

主要技术参数. Main Specification

型号. Model	PLXYC-05
长. Length	1300mm
宽. Width	740mm
高度. Height	1170-1600mm



PLVT-01 电动宠物美容台

Electric Pet Grooming Table

该宠物美容台整体银灰色造型，科技感十足。采用国产第一品牌捷昌电机，经久耐用。

The pet grooming table has snow silver color which makes it a sense of technology. It uses China most famous brand "jiechang" Motor, which can be used for many years.

主要技术参数. Main Specification

型号. Model	PLVT-01
台面长度. Table Top Length	1250mm
台面宽度. Table Top Width	650mm
高度. Height	250-950mm



25cm 超低位台面
25cm lowest height



脚踏控制器
Foot pedal controller



防水纤维台面
Water proof fiber table top



电源插座
Electric sockets



国产第一品牌捷昌电机
China most famous brand "Jiechang" motor



吹风机挂钩
Hair dryer hooks



PLHG-A01 自动宠物烘干室 Automatic Pet Dryer Room PLHG-A01

全液晶控制屏, 风力三档可调
LCD control panel, wind 3 steps adjustable



PLHG-A01适用于宠物猫或者小型犬。
PLHG-A01 is suitable for cats or small dogs.

型号Model	PLHG-A01
内部尺寸Internal Size(cm)	40*40*40
外部尺寸External Size(cm)	44*51*75
净重Net Weight	42kg
功率Power	1200W

PLHG-A02 自动宠物烘干室 Automatic Pet Dryer Room PLHG-A02

PLHG-A02
适用于威尔斯柯基犬、猎兔犬、斗牛犬等中型犬。



PLHG-A02适用于中型犬。
PLHG-A02 is suitable for middle dogs.

型号Model	PLHG-A02
内部尺寸Internal Size(cm)	60*60*60
外部尺寸External Size(cm)	76*71*91
净重Net Weight	63kg
功率Power	3200W

PLHG-A03 自动宠物烘干室 Automatic Pet Dryer Room PLHG-A03

自动宠物烘干室是柜式的干燥室，用于宠物干燥和空气浴。

拥有红外理疗，臭氧杀菌，自动烘干，毛发收集功能。

Automatic pet dryer room is cabinet type. It is used for pets drying and air-shower.

It has infrared care, O₃ sterilize, automatic dry, hair collection functions.

26只出风口，烘干效果更快 26 pcs wind outer, fast to dry

全液晶控制屏，风力三档可调 LCD control panel, wind 3 steps adjustable



PLHG-A03适用于2只中型犬或者一只大型犬。
PLHG-A03 is suitable for two middle dogs
at the same time or for one large sized dog.

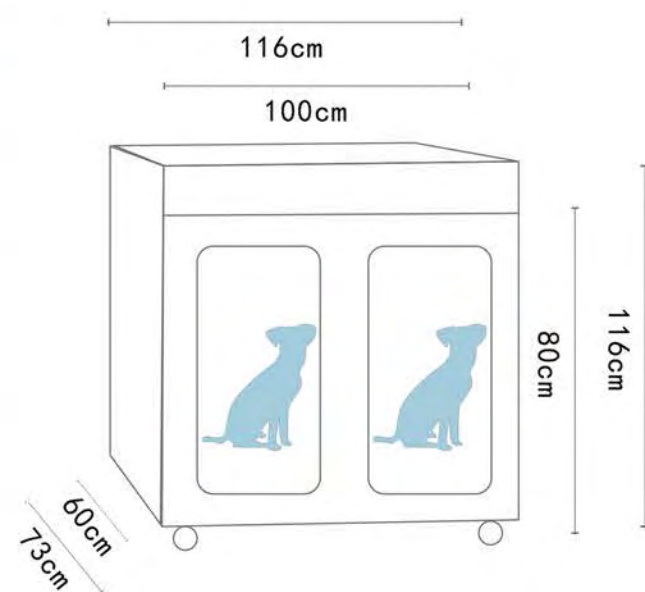

型号 Model	PLHG-A03
内部尺寸 Internal Size (cm)	100*60*80
外部尺寸 External Size (cm)	116*73*116
净重 Net Weight	115kg
功率 Power	5000W